

FOREST

DRAPERY HARDWARE



DS[®]
Design System

Product information

- Elegant and aesthetically pleasing hand drawn system for all types of medium weight draperies.
- Quick installation with "Smart Klick" brackets for wall and ceiling applications.
- Bendable; it can be curved for outside bends only using a 10 cm (4") radius or continuous curved.
- Hidden brackets through elegant shape of the track.
- Same brackets as used with KS system.
- Heavy duty clickable carriers - UV protected - for smooth and easy traversing. Offset shape for straight hanging pleats.
- Can also be used for ripplefold and accordiafold drapery systems.
- Maximum fabric weight: 8 kg per meter (6 LBS per ft.).
- Colours available: white and silver.
- Special colours: available on request.
- Available lengths: 4 meter (13'1"), 5 meter (16'4"), 6 meter (19'8").
- Track finish: chromated powder coating with a factory applied patented dry lubricant.
- Limited lifetime warranty.

Applications

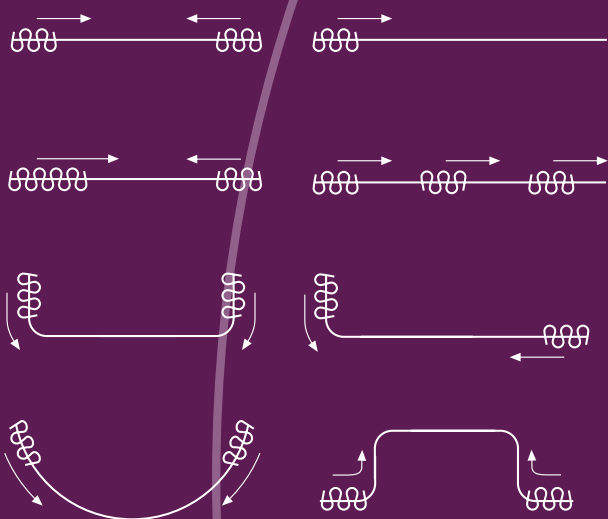

For use in

Hotels - offices - schools - healthcare - residences - boats - campers - planes or at any location where an elegant efficient hand drawn system is required.

Profile

- Shown actual size 1:1.
- Aluminum Extrusion.
- Weight: 170 grams per meter (1.83 ounce per ft.).
- Dimensions: 11 mm x 24 mm (0,4" x 0,9").

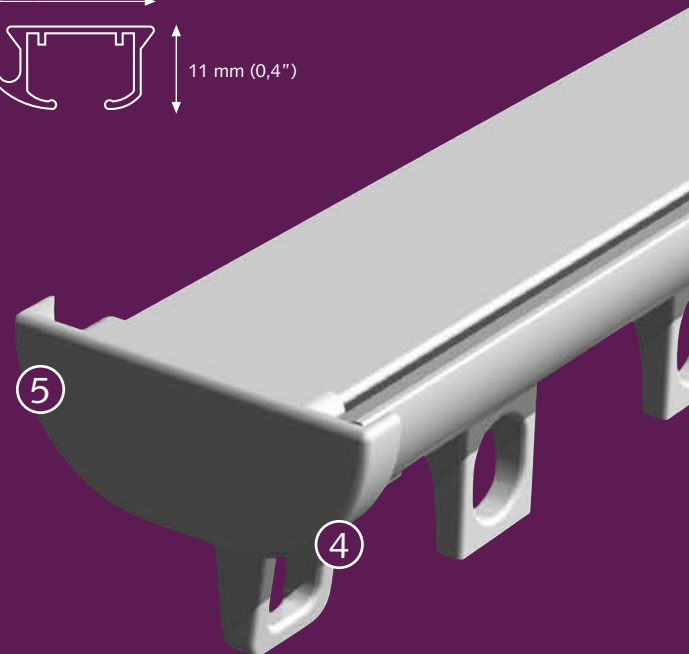
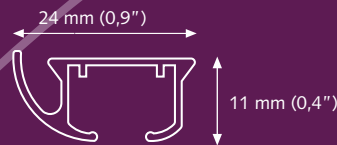

Bending/ curving

The track can be curved for outside bends by using a 10 cm (4") radius. Continuous curving is available by special order from factory only.



- ① DS track
- ② Carrier
- ③ Stop carrier
- ④ End stop
- ⑤ End cap

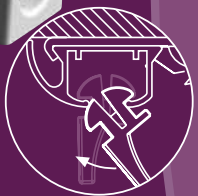
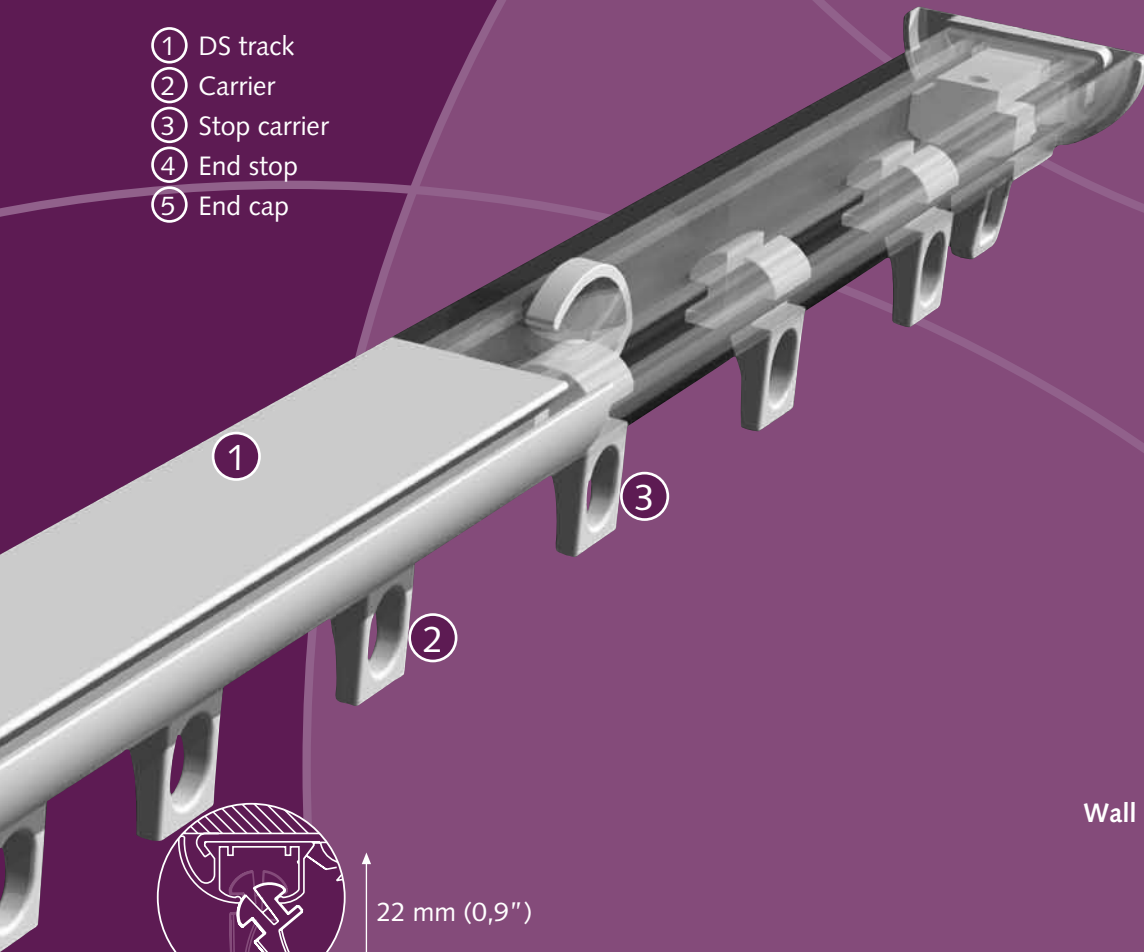

22 mm (0,9")

clickable carrier



Easy installation
click - position - tighten

• Other brackets are available. Brackets need to be placed every 60 cm (24").

Mounting Brackets

Ceiling Bracket



4,2 cm (1,7")

4,2 cm (1,7")

Wall bracket

3,5 cm (1,4")

6 cm (2,4")



3,5 cm (1,4")

3,5 cm (1,4")

3 cm
(1,2e")

Wall bracket aluminium single

7,5 cm (3")

10 cm (4")

15 cm (6")

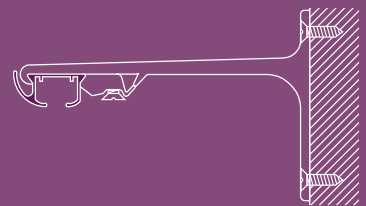

Wall bracket aluminium double

15 cm (6")

20 cm (8")

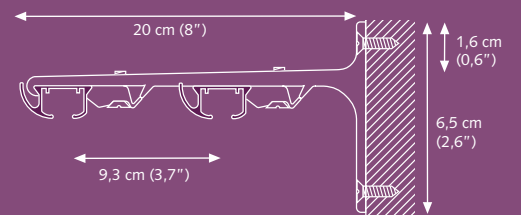

20 cm (8")

1,6 cm
(0,6")

6,5 cm
(2,6")

9,3 cm (3,7")

Colours available from stock:

Complete the art.nr. with the indicated colour-code

01 White**03 Silver**

Other colours can be delivered on request.

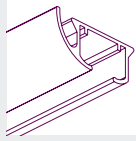
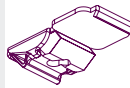
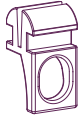
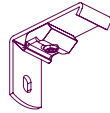
**DS Track**Aluminium extrusion, powder coated, lubricated.
4 m (13'1"), 5 m (16'4"),
6 m (19'8").20010.. .00 cm
20/tube**Klick on Splice**For ceiling and wall installation,
powder coated.
Colours:01, 02, 03, 05, 06.10184..000
50/box**Smart Klick Ceiling Bracket**"Klicks" onto track, powder coated.
Install with VK screw 4 mm.10182..000
100/box**Carrier**"Klickable", offset, constructed of
UV resistant plastic. 10 Carriers on
a break-away strip. Can be clicked
in after installation.10100..000
500/box**Smart Klick Wall Bracket**3,5 cm (1,4") and 6 cm (2,4").
"Klicks" onto track, powder
coated. One screw attachment.
For light weight use only.

50/box

10202..035

10202..060

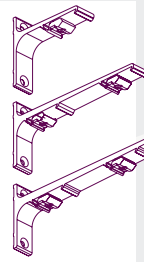
**Stop Carrier**Prevents slide back, "klickable",
constructed of UV resistant plastic.10102..000
250/box**Aluminium Wall bracket**

Smart klick, powder coated.

10203.. ...mm

7,5 cm single (3")

20/box

10 cm single (4")

20/box

15 cm double (6")

15/box

20 cm double (8")

15/box

25 cm triple (10")

10/box

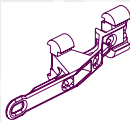
**Master Carrier/Reversible**Reversible overlap carrier, "Klicks"
into track, constructed of UV
resistant plastic. For straight track
only. White.1010301000
25/box**Shirrtape Carrier**Carrier and hook in one "klickable"
unit, constructed of UV resistant
plastic. For sew on drapery tape.10104..000
500/box**Compact Bending House**

For DS

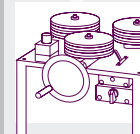
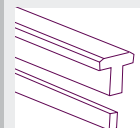
1050000000
1/each**Carrier with Metal Hook**"Klickable", offset, with stainless
steel hook, constructed of UV
resistant plastic. For use with
grommets.10105..000
100/box**Electric Powered Bender**Available in 230V or 115V, to create
continuous curves and arches. Minimum
radius 50 cm (20").1060500000
1/box**Twist End Stop**"Twists" into track, with metal
plate, constructed of UV resistant
plastic.10162..000
100/box**Replacement Bending Strips**

For DS Compact Bending Tool.

Length of strip: 60 cm (23").

For DS electric powered bender.

Length of strip: 7 m (23').

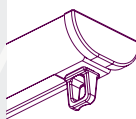
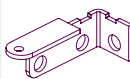
2060100000
1/set2060300000
1/set**Twist End Stop with Cap**"Twists" into track, with metal plate
and end cap, constructed of UV
resistant plastic.20163..000
100/box**Bending Wheels**For electric powered bender.
Complete set of 3 wheels for DS
track only. No arches can be made.2060700000
1/set**Wall Support**2,5 x 5 cm (1" x 2") return plate,
powder coated. Right
Left

25/box

10166..000

10167..000

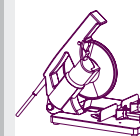
**Electric Powered Railcutter**

230 Volt EU

115 Volt USA

230 Volt UK

1061100000

1061200001

1061200002

1/each

Replacement Blade

For electric powered railcutter.

1061200000

1/each

**Ceiling Bracket**Slides onto the track, powder
coated. Regular duty.10180..000
100/box**Ceiling Bracket with Slot**Slides onto the track, powder
coated. Regular duty.10181..000
100/box

Distributor:

FOREST
DRAPERY HARDWARE